



This attachment is approved but not supplied by JCB.

WHEELED EXCAVATOR | JS175W

Engine power: 129kW (172hp) Operating weight: 15,010 – 18,417kg Bucket capacity: 0.265 – 0.995m³



STRENGTH INSIDE AND OUT.

BEFORE YOU BUY AN EXCAVATOR, YOU NEED TO KNOW IT'S GOING TO BE TOUGH ENOUGH TO PERFORM ANY JOB YOU ASK OF IT. FORTUNATELY, WITH A JCB JS175W, STRENGTH AND DURABILITY COME AS STANDARD.



1

Boom and dipper.

1 A JS175W's reinforced boom and dipper is made of high tensile strength steel, with single piece wrapper plates and internal baffle plates for long life durability.

2 Our advanced manufacturing and assembly processes produce high precision and quality assembled components.

Componentry.

3 Our engine technology is tried and proven; we've built 200,000 DIESELMAX units since 2004. To ensure similar longevity, the JS175W EcoMAX T4 Final engine has been tested for 110,000 hours in 70 different machines across the toughest applications and environments.

4 JCB JS175W boast the best components in the industry, that includes a JCB engine, Kawasaki pumps, Kayaba valve blocks and a choice of ZF or JCB axles. The JCB JS175W's selectable axle lock allows the operator to easily and conveniently adapt the machine to the task and terrain at hand.



2



3

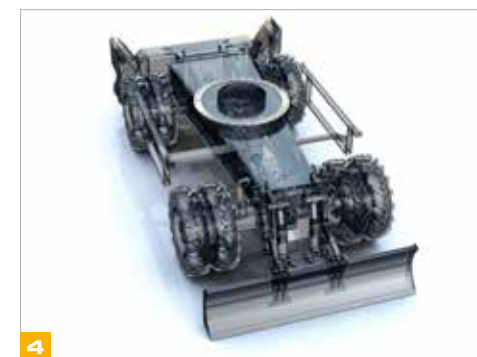

4

Structural strength.

- 5 The JS175W makes light work of those day to day lifting tasks which are essential on almost all working locations. With a combination of high lifting performance and good stability the JS175W saves time by being able to carry out the tasks of many machines on its own.
- 6 Our heavy-duty axles, dozers and stabilisers are designed for the toughest of applications. Available in a wide range of configurations, ensuring that it can be tailored to suit the job at hand.
- 7 A closed box section revolving frame increases strength and reduces stress. It's also highly resistant to impact damage.
- 8 The high-strength rigid upper frame provides maximum durability and support.
- 9 Our stiff, durable door design gives great strength and rigidity.

The JS175W is available with either a mono or two piece boom.



This attachment is approved but not supplied by JCB.

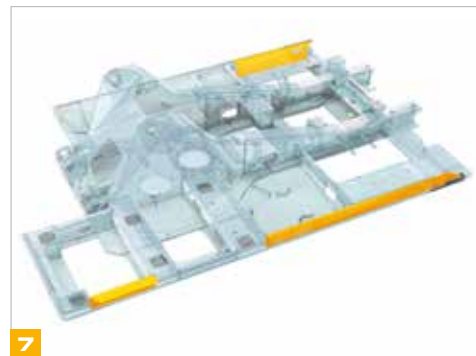

MAXIMUM PRODUCTIVITY, MINIMUM SPEND.

IT'S MORE IMPORTANT THAN EVER TO SAVE MONEY AND TIME; THE NEW JCB JS175W WITH THE NEW ECOMAX T4F ENGINES ARE DESIGNED TO WORK IN HARMONY TO DELIVER OUR MOST PRODUCTIVE AND EFFICIENT WHEELED EXCAVATOR.

Versed in versatility.

1 JCB's quickhitch system makes attachment changing fast and easy and is purpose-designed for the JS range which means the JS175W can adapt to a wide range of working applications just by adding a different JCB attachment. For ultra versatility, JCB offers a full list of auxiliary pipework options including hammer, auxiliary and low flow.

2 The hydraulic raised cab option on JS175W enables the raising of the operating station up to 2.3m above the standard machine. This enables the operator to see into higher sided containers that are being loaded, minimising damage, maximising productivity and improving site safety.

3 For the optimum in productivity, the JS175W can be fitted with a tiltrotator for additional 45 degree tilt and 360 degree rotation between the arm and attachment. Our innovative tiltrotator ready installation provides a dedicated flow independent of other hydraulic demands. Combined with purpose designed joysticks which include steering controls, this provides unrivalled tiltrotator performance.



1



2



This attachment is approved but not supplied by JCB.



This attachment is approved but not supplied by JCB.



3



3

Lifting, excavating, grading, unloading or with attachments, the JS175W is a multi-work tool designed to be more productive by being able to cover a wide range of tasks with ease and precision.

Upping output.

4 To complement the smooth and consistent drive, the JS175W comes as standard with forward/neutral/reverse controls, conveniently located on the right hand joystick.

JCB's innovative hydraulic regeneration system means oil is recycled across the cylinders for faster cycle times and reduced fuel consumption. Advanced hydraulic technology, optimised hydraulic pump settings and enhanced design of electronic management software gives optimum fuel efficiency.

The efficient excavator.

5 JCB's new EcoMAX T4 Final engine uses less fuel than our Tier 4i units, saving you money. This is partly due to the fact that EcoMAX produces high torque at just 1500 – 1600 rpm, making for improved fuel-efficient matching of the hydraulics.

6 The JS175W's variable power bands allow you to tailor performance and therefore maximise efficiency. A new proportional control system for the engine cooling fan enables optimised fan speed, reducing noise pollution caused by unnecessary air flow, helping to reduce fuel consumption.

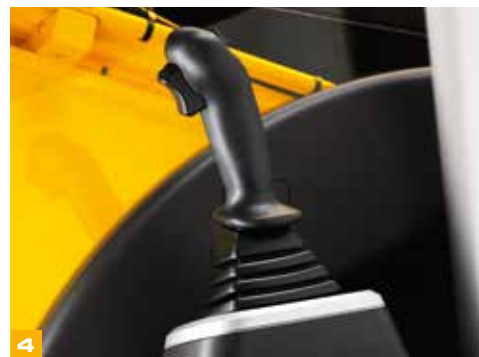

A COMFORTABLE FAVOURITE.

WE'VE DESIGNED THE JCB JSI75W TO BE VERSATILE, COMFORTABLE, ERGONOMIC AND INTUITIVE TO OPERATE. WHICH IS GOOD FOR YOUR OPERATORS BUT EVEN BETTER FOR YOU; AFTER ALL, GREAT EASE OF USE EQUALS GREAT PRODUCTIVITY.

The working environment.

1 The JSI75W offers a quieter working environment inside and out. Because we've reduced noise levels to 73dB(A) internal and 100dB(A) you can use the machine in any location, any time.

The JCB JSI75W cab uses 6 viscous rubber mounts to minimise noise and vibration.

2 Light, intuitive and smooth controls improve comfort and productivity. Joystick mounted power boost button allows for quick access of extra hydraulic power.

Proportional auxiliary control options offer smooth, precise control, improved multifunctionality and further fuel savings.

3 The robust steering column and controls are independently adjustable so that it's simple to find the perfect operating position.

4 Rearward visibility is excellent thanks to the very compact EcoMAX T4F engine which is innovatively packaged under a low level bonnet.



The JSI75W's independently adjustable controls make it easy to find the perfect operating position.

We offer a range of seats to suit all applications, including heated and ventilated options.



5

Comfortably in control.

5 JCB JS175W has a spacious luggage tray behind the operator's seat. With an auxiliary power socket, ideal for cool boxes.

6 JCB's climate control option offers a precisely controlled cab temperature with fresh or recirculated air. Demisting/defrosting functions keep the front window clear.

7 Work mode selection is done via the rotary throttle control, allowing the operator simple, quick and easy selection from one dial.

8 Conveniently located dozer and stabiliser controls coupled with smooth and responsive joysticks offer great control of the JS175W allowing for maximum productivity and ease of use.

9 The standard 7" full colour multi function display is easy to read in all light conditions and provides instant access to information on the machine operation. With customisable home screens the operator can choose what information they want to see.



6



7



8



9



A large laminated glass roof and window gives the JS175W optimum visibility when working at height.



The JS175W's joystick mounted power boost button gives extra hydraulic power fast.

A balanced slew and electrohydraulic controlled slew braking give good speed and precision.



9

LESS SERVICING, MORE SERVICE.

WE'VE DESIGNED THE JCB JSI75W TO BE LOW MAINTENANCE AND EASILY SERVICEABLE. WHICH MAKES THEM AFFORDABLE, EFFICIENT AND HIGHLY PRODUCTIVE. HELPING YOU GET THE BEST SERVICE FROM YOUR MACHINE.



1

Easy does it.

1 Our innovative recalibration option allows EcoMAX to run on lower grade fuels. This means the JSI75W can be resold across different territories, which improves residuals.

2 The filters on a JCB JSI75W (engine oil, hydraulic oil and fuel) are centrally located for fast, easy servicing.

3 The easily located air filter makes removal and inspection simple. Because they're mounted side by side, the engine radiator, hydraulic cooler and intercooler can be serviced individually yet easily cleaned.

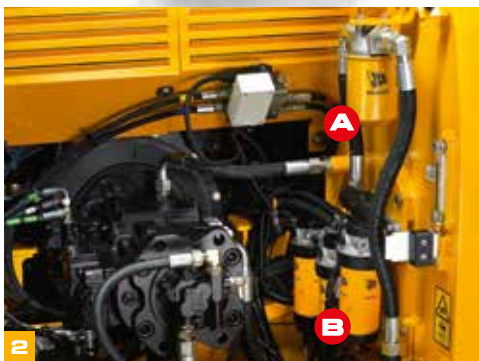

(A) Hydraulics oil filters (B) Fuel filters



SERVICE INTERVALS	
Engine oil and oil filter	Every 500 hours
Hydraulic oil	Every 5000 hours
Hydraulic oil filter	Every 1 000 hours



3

Here to help.

4 The JCB JS175W as standard is fitted with a single point grease system which is conveniently located at ground level for ease of access and use.

5 We've eliminated the need for a visibowl style pre-cleaner on the JS175W with our optional scavenger filtration system. This uses suction from the cooling fan to remove heavier particles from the induction system, helping to extend your air filter change intervals.

Unlike most Tier 4 Final engines, JCB EcoMAX doesn't use a Diesel Particulate Filter (DPF) saving you additional running costs.

6 JCB JS175W bonnets open and close easily with gas-assisted cylinders, and the service bays are large and wide for good access.

7 JCB's NEW In-Cab Monitor checks engine oil levels and system errors on start-up.



4



5



6



7

THE SAFE CHOICE.

ON-SITE SAFETY IS CRUCIAL, SO WE'VE DESIGNED THE JSI75W TO INCORPORATE AS MANY CUTTING EDGE SAFEGUARDS AS POSSIBLE. IN SHORT, YOUR OPERATORS ARE IN SAFE HANDS.

Safety as standard.

1 Steps and platforms have anti-slip punched steel plates for optimum grip, even in wet or icy conditions. Bolt-on plates have recessed bolts to reduce trip hazard.



2 JCB's JSI 75W comes as standard with a rear-view camera displaying an uninterrupted backwards view on an in-cab 7" colour monitor. An optional side view camera can also be fitted to further improve the field of vision.



3 JCB's 2GO system fully isolates hydraulic functions to avoid unintended movements. Our start function means a JCB JSI 75W can only be moved when in a safe condition via two separate inputs with the footbrake pressed.



Visibly better.

- 4** JCB JS175W has a large glass area and low bonnet line for superb all round visibility.
 - 5** The JCB JS175W is equipped with a full set of side and rear view mirrors for all-round visibility and safety compliance.
 - 6** Optional safety rails provide protection against falls from height for any operatives carrying out activities whilst on the upper structure of the vehicle.
 - 7** There's no need to climb onto the JS175W to check oil levels; all routine servicing can be done from ground level.
 - 8** Choose the LED work lights for an even better field of vision for the operator over standard work lights.
- Optional beacons can improve on-site safety still further.
- 9** For extra peace of mind, JCB JS175W cabs are available with an integral rollover protection structure (ROPS). It's easy to fit JCB's FOPS (Falling Objects Protection Structure) to a JS175W cab, thanks to standard fitment mounting brackets.



9



6



7



8

LIVELINK, WORK SMARTER.

LIVELINK IS AN INNOVATIVE SOFTWARE SYSTEM THAT LETS YOU MANAGE JCB MACHINES REMOTELY – ONLINE, BY EMAIL OR BY MOBILE PHONE. ACCESS EVERYTHING FROM MACHINE ALERTS TO FUEL REPORTS AND HISTORY INFORMATION, WITH ALL DATA STORED AT A SECURE CENTRE.

Productivity and cost benefits

By providing information like idle time monitoring and machine fuel consumption, JCB Livelink helps reduce your fuel usage, saving money and improving productivity. Machine location information can help improve efficiency and perhaps even reduce insurance costs.



Maintenance benefits

Manage machine maintenance easily – accurate hours monitoring and service alerts improve maintenance planning, while real-time location data helps you manage your fleet. Critical machine alerts and maintenance history records are also available.



Security benefits

Livelink's real-time geofencing alerts tell you when machines move out of predetermined zones, and real-time curfew alerts inform you of unauthorised usage. Further benefits include real-time location information, advanced ECU matching (pairs Livelink with the immobiliser or ECU).



VALUE ADDED.

JCB'S WORLDWIDE CUSTOMER SUPPORT IS FIRST CLASS. WHATEVER YOU NEED AND WHEREVER YOU ARE, WE'LL BE AVAILABLE QUICKLY AND EFFICIENTLY TO HELP MAKE SURE YOUR MACHINERY IS PERFORMING TO ITS FULL POTENTIAL.



1

1 Our Technical Support Service provides instant access to factory expertise, day or night, while our Finance and Insurance teams are always on hand to provide fast, flexible, competitive quotes.

2 The global network of JCB Parts Centres is another model of efficiency; with 15 regional bases, we can deliver around 95% of all parts anywhere in the world within 24 hours. Our genuine JCB parts are designed to work in perfect harmony with your machine for optimum performance and productivity.



2

3 JCB Assetcare offers comprehensive extended warranties and service agreements, as well as service-only or repair and maintenance contracts. Irrespective of what you opt for, our maintenance teams around the world charge competitive labour rates, and offer non-obligation quotations as well as fast, efficient insurance repair work.

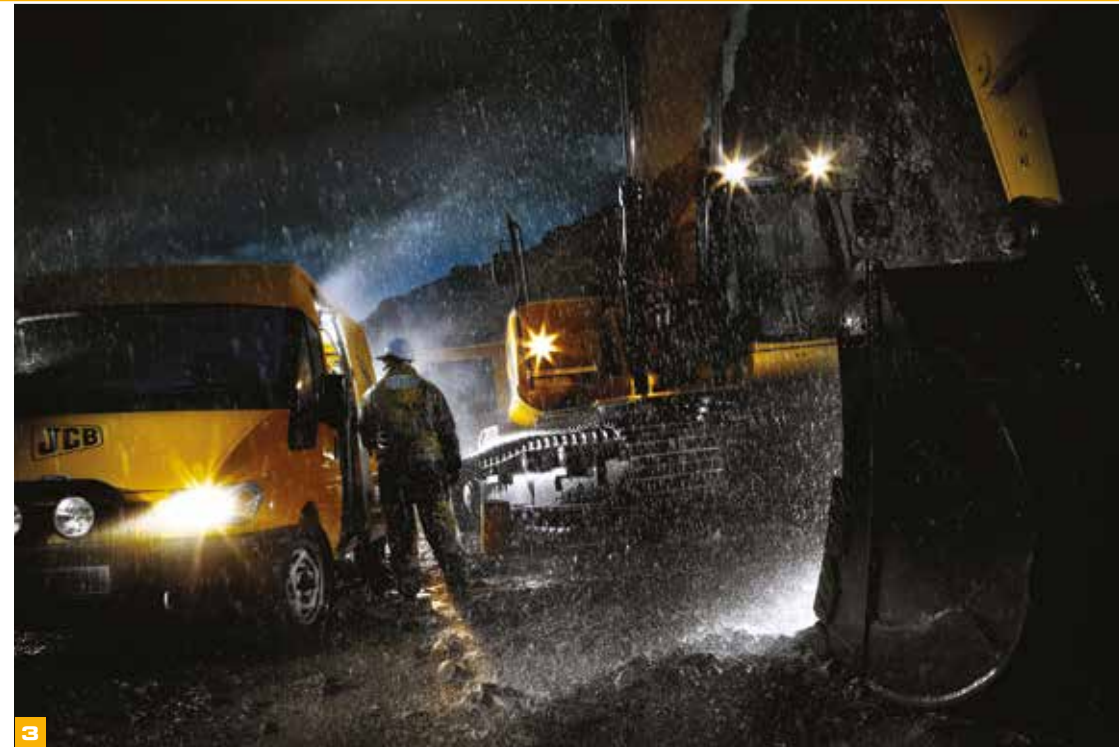

3

Note: JCB LIVELINK and JCB ASSETCARE may not be available in your region, so please check with your local dealer.

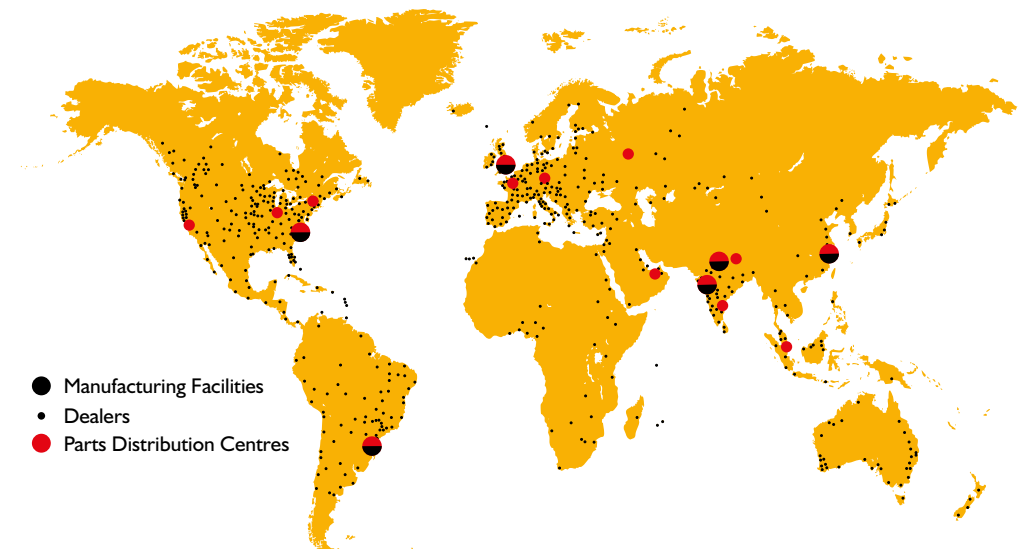

STATIC DIMENSIONS

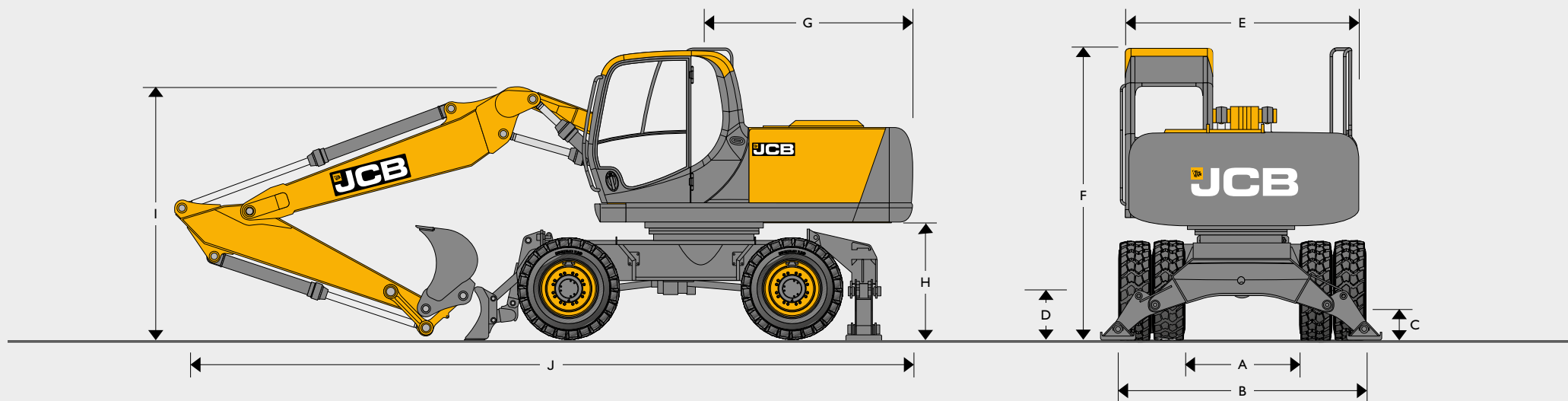

A	Internal width between dual wheels	mm	1330
B	External width over dual wheels	mm	2490
C	Ground clearance	mm	350
D	Height to axle centre line dual wheels	mm	498
	Height to axle centre line single wheels	mm	519
E	Overall width (handrail removed)	mm	2480
F	Height over cab	mm	3195
G	Tail length	mm	2330
H	Clearance under counterweight	mm	1270

Monoboam 5.15m

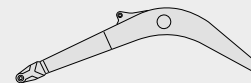

Dipper length			2.25m	2.70m	3.05m
I	Transport boom height	mm	2765	2765	3240
J	Transport length	mm	8285	8275	8446

Triple Articulated Boom 4.97m

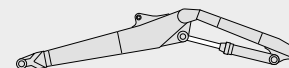

Dipper length			2.25m	2.70m	3.05m
I	Transport boom height	mm	2806	2874	3136
J	Transport length	mm	8263	8258	8223

CHASSIS OPTIONS

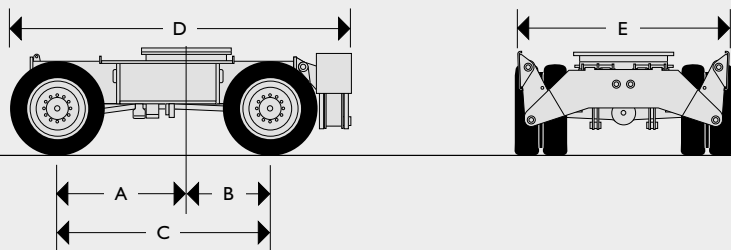

STABILISERS REAR

A	Centre of slew ring to front axle	mm	1500
B	Centre of slew ring to rear axle	mm	1000
C	Wheelbase	mm	2500
D	Length including rear stabilizers	mm	3950
E	Width over stabilizers (raised)	mm	2480

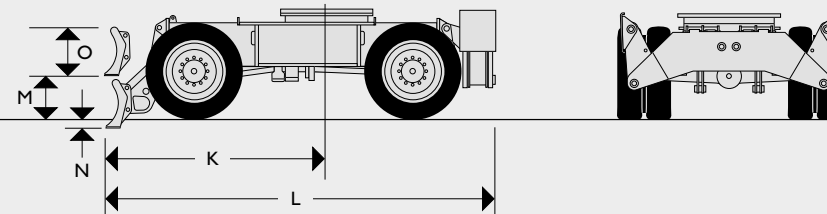

DOZER FRONT STABILISER

K	Centre of slew ring to front dozer blade (lowered)	mm	2530
L	Length including stabilizers and dozer blade (raised)	mm	4460
M	Ground level to bottom of front dozer blade (raised)	mm	450
N	Dozer blade dig depth	mm	130
O	Dozer blade height	mm	500

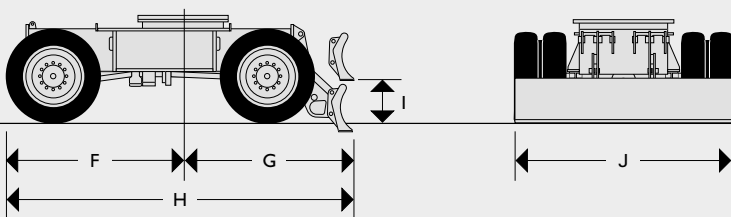

DOZER REAR

F	Centre of slew ring to face of front tyre	mm	1990
G	Centre of slew ring to rear dozer blade (lowered)	mm	2090
H	Length including rear dozer blade (raised)	mm	4050
I	Ground level to bottom of rear dozer blade (raised)	mm	450
J	Dozer blade width	mm	2480

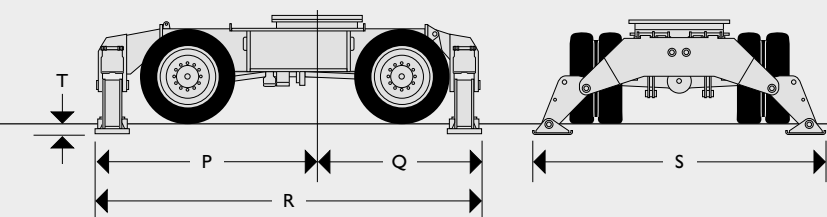

STABILISERS FRONT & REAR



P	Centre of slew ring to front stabilizers	mm	2520
Q	Centre of slew ring to rear stabilizers	mm	1960
R	Length including front and rear stabilizers	mm	4480
S	Width over stabilizers (lowered)	mm	3550
T	Stabilizer lift height	mm	130

ENGINE	
Model	JCB EcoMAX 448 TCA EU Stage IV.
Type	4-stroke, 4-cylinder in-line, common rail, direct injection, turbocharged and intercooled diesel.
Rated power (ISO14396)	129kW (172hp) @2050rpm.
Piston displacement	4.8 litres.
Injection	Electronic injection.
Air filtration	Dry element with secondary safety element and in cab warning indicator.
Cooling	Large capacity radiator.
Starting system	24 volt – 4kW.
Batteries	2 x 12 volt.
Alternator	24 volt 55 amp.
Refuelling pump	Electric type (optional).

SWING SYSTEM	
Drive train	Axial piston motor and planetary reduction final drive.
Swing brake	Hydraulic braking plus automatic spring applied disc type parking brake.
Swing speed	11.3 rpm
Swing gear	Large diameter, internally toothed fully sealed grease bath lubricated.
Swing lock	Multi position switchable brake and mechanical lock.

CHASSIS		
Chassis options	2.5m ZF hub brake axles / 2.5m JCB disc brake axle.	
Dozer blade	Front or rear pin mount.	
Stabilisers	Front or rear pin mount, independently operable – plus combinations.	
Grab stowage	Heavy duty, pin mounted stowage bar.	
Axles	Four wheel drive.	
Axle load capacity	32 tonnes.	
Axle oscillation	+/- 8.5 degrees.	
Ground clearance	350mm.	
Transmission	Hydrostatic drive via piston motor and powershift transmission.	
Travel speed	Creep speed	3.8kph (ZF) / 3.8kph (JCB)
	Low ratio	14kph (ZF) / 14kph (JCB)
	High ratio	30kph (ZF) / 30kph (JCB)
Drawbar pull	99.7 kN (JCB Axle), 102.5 kN (ZF Axle)	
Steering	Fully hydraulic system.	
Turning radius		
	To outside of tyres	6.5m.
	To outer edge of front mounted dozer blade	6.558m.
Brakes	All hydraulic, dual circuit brake system.	
Parking brake	Built into the transmission.	
Gradeability	35° 70% max. continuous.	

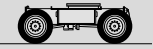
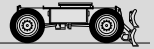
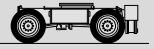
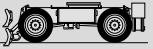
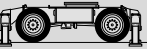
TYRES		
Twins	Single	Flotation
10.00 x 20 tyres (16PR) with spacer ring	18R x 19.5 tyres (Radials)	600/40 x 22.5

OPERATING WEIGHTS					
Chassis					
	15010kg	15710kg	16316kg	17022kg	17628kg
	15793kg	16493kg	17105kg	17811kg	18417kg

Machine equipped with 2.7m dipper, excavating bucket and dual wheels. For single wheels subtract 400kg.

BUCKET AND ARM COMBINATION							
	No quickhitch fitted			Quickhitch fitted*			
JS175W Mono							
Arm length	2.25m	2.7m	3.0m	2.25m	2.7m	3.0m	Bucket weight
GP bucket 610mm 0.34m ³	□	□	□	□	□	□	368kg
GP bucket 762mm 0.46m ³	□	□	■	■	■	●	460kg
GP bucket 914mm 0.59m ³	■	■	●	●	●	×	511kg
GP bucket 1067mm 0.72m ³	●	●	×	×	×	×	579kg
GP bucket 1219mm 0.85m ³	×	●	×	×	×	×	625kg
JS175W Tab							
Arm length	2.25m	2.7m	3.0m	2.25m	2.7m	3.0m	Bucket weight
GP bucket 610mm 0.34m ³	□	□	□	□	□	□	368kg
GP bucket 762mm 0.46m ³	□	□	□	■	■	□	460kg
GP bucket 914mm 0.59m ³	■	■	□	●	●	■	511kg
GP bucket 1067mm 0.72m ³	●	●	■	×	×	×	579kg
GP bucket 1219mm 0.85m ³	●	●	●	×	×	×	625kg

Notes: Bucket compatibility based upon lift values (ISO 10567) for a free on wheels machine, compatibility will change based upon chassis options.

- = Suitable for general excavating (materials up to 2000kg/cu.m).
- = Suitable for light excavating (materials up to 1600kg/cu.m.)
- = Suitable for grading & loading materials up to 1200kg/cu.m).
- ×

* Bucket capacity using JCB quickhitch only (quickhitch = 186kg).

SERVICE CAPACITIES		
Fuel tank	litres	310
Engine coolant	litres	26
Engine oil	litres	20.4
Swing reduction gear	litres	6
Hydraulic system	litres	124
Hydraulic tank	litres	73
Transmission	litres	2.5
Axle differentials (each)	litres	Rear 12, Front 14
Axle hubs (each)	litres	2.0
DEF fluid capacity	litres	31.4

MAIN HYDRAULIC SYSTEM	
System	Open centred, negative control hydraulic system with twin variable flow piston pumps providing flow-on-demand for maximum efficiency.
Main pumps	2 variable displacement axial piston type.
Maximum flow	2 x 156 l/min.
Main circuit pressure	314 bar.
With power boost	343 bar.
Servo pump	Gear type.
Maximum flow	27 l/min.
Servo pressure	40 bar.
Optional circuits	
Hammer	Includes automatic engine speed setting and return filter.
Maximum flow	138 l/min.
Maximum pressure	314 bar (pre-set to 180 bar).
Aux double acting	
Maximum flow	130 l/min.
Maximum pressure for grab ram operation	314 (343) bar.
Low flow pipework	Gear pump max flow 36 l/min.
Hydraulic cylinders	Hardened, chromed piston rods and end cushioning on boom, dipper and bucket crowd cylinder.
Filtration	
In tank	150 micron, suction strainer.
Main return line	10 micron, fibreform element.
Pilot line	10 micron, paper element.
Hydraulic hammer return	10 micron, reinforced microform element.
Cooling	Worldwide cooling is provided by a single faced engine water, hydraulic oil and intercooler with swing forwards air conditioning condenser for easy cleaning.

WORKING RANGES

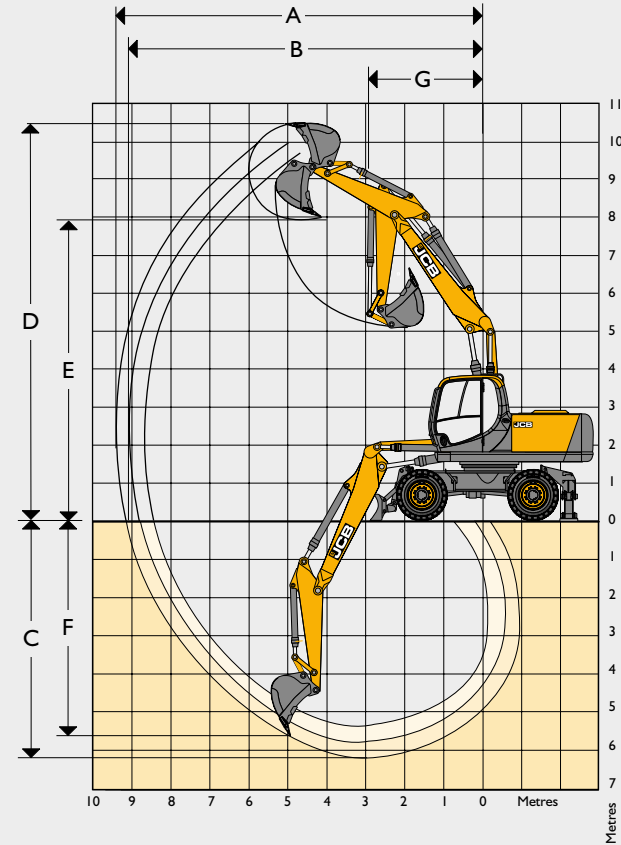
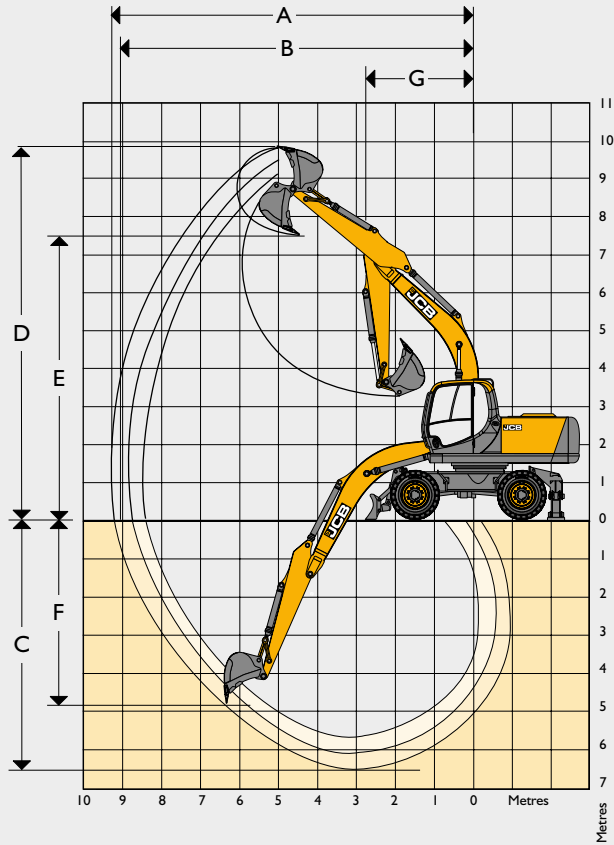

5.15m Monoboom

Dipper length		2.25m	2.70m	3.05m	
A	Max digging reach	mm	8592	8974	9483
B	Max digging reach (on ground)	mm	8386	8776	9234
C	Max digging depth	mm	5682	6120	6256
D	Max digging height	mm	9102	9237	9688
E	Max loadover height	mm	6636	6805	7174
F	Max vertical wall cut depth	mm	3826	4178	4839
G	Min swing radius	mm	3019	2961	2971
	Bucket rotation		183°	183°	183°
	Dipper tearout	kgf	10128	8440	7470
	Dipper tearout with boost	kgf	10990	9160	8100
	Bucket tearout	kgf	10400	10400	10400
	Bucket tearout with boost	kgf	10740	10740	10740

4.97m T.A.B.

Dipper length		2.25m	2.70m	3.05m	
A	Max digging reach	mm	8600	9025	9350
B	Max digging reach (on ground)	mm	8400	8850	9195
C	Max digging depth	mm	5300	5750	6100
D	Max digging height	mm	9700	10000	10235
E	Max loadover height	mm	7000	7325	7575
F	Max vertical wall cut depth	mm	4450	4900	5250
G	Min swing radius	mm	2725	2675	2635
	Bucket rotation		183°	183°	183°
	Dipper tearout	kgf	9035	7530	6665
	Dipper tearout with boost	kgf	9600	8100	7235
	Bucket tearout	kgf	10400	10400	10400
	Bucket tearout with boost	kgf	10740	10740	10740

LIFT CAPACITIES – DIPPER LENGTH: 2.25M, 5.15M MONOBOOM, REAR DOZER, NO BUCKET.													JSI175W MONO
Reach	1.5m		3m		4.5m		6m		7.5m		Capacity at Max Reach		mm
													
Load Point Ht.	kg	kg	kg	kg	kg	kg	kg	kg	kg	kg	kg	kg	kg
7.5m					4360*	4360*					3830*	3830*	4620
6.0m					5080*	4470	3530*	2760			3330*	2740	6031
4.5m					5710*	4260	4890*	2730			3190*	2190	6838
3.0m					6740*	3940	5250*	2600			3230*	1940	7248
1.5m					7530*	3650	5580*	2470			3440*	1850	7330
0m			5580*	5580*	7600*	3510	5600*	2380			3880*	1910	7094
- 1.5m	6310*	6310*	9440*	6460	6950*	3490	5060*	2370			4400*	2150	6508
- 3.0m	8760*	8760*	7190*	6620	5360*	3580					4000*	2790	5454
- 4.5m			2810*	2810*							2280*	2280*	3524

LIFT CAPACITIES – DIPPER LENGTH: 2.70M, 5.15M MONOBOOM, REAR DOZER, NO BUCKET.													JSI175W MONO	
Reach	1.5m		3m		4.5m		6m		7.5m		Capacity at Max Reach		mm	
														
Load Point Ht.	kg	kg	kg	kg	kg	kg	kg	kg	kg	kg	kg	kg	kg	
7.5m												2880*	2880*	5238
6.0m							4040*	2860				2580*	2460	6514
4.5m					5290*	4370	4610*	2780				2500*	2010	7266
3.0m			9710*	7300	6360*	4010	5040*	2630	3370*	1860		2540*	1800	7653
1.5m			5120*	5120*	7290*	3680	5450*	2480	4100*	1800		2690*	1710	7731
0m			6660*	6250	7590*	3480	5600*	2360	3080*	1750		3020*	1750	7508
- 1.5m	6070*	6070*	10140*	6280	7170*	3420	5280*	2320				3630*	1930	6957
- 3.0m	10160*	10160*	8130*	6430	5930*	3480						4020*	2400	5985
- 4.5m			4570*	4570*								3120*	3120*	4307

LIFT CAPACITIES – DIPPER LENGTH: 3.05M, 5.15M MONOBOOM, REAR DOZER, NO BUCKET.													JSI175W MONO	
Reach	1.5m		3m		4.5m		6m		7.5m		Capacity at Max Reach		mm	
														
Load Point Ht.	kg	kg	kg	kg	kg	kg	kg	kg	kg	kg	kg	kg	kg	
7.5m												2400*	2400*	5690
6.0m							3840*	2860				2170*	2170	6881
4.5m							4350*	2780	2500*	1890		2110*	1840	7596
3.0m			8930*	7540	6020*	4060	4830*	2630	3790*	1840		2150*	1650	7967
1.5m			6790*	6590	7070*	3700	5300*	2460	4270	1760		2280*	1580	8041
0m			6950*	6270	7540*	3470	5540*	2340	4200	1710		2540*	1600	7828
- 1.5m	5610*	5610*	9860*	6240	7290*	3390	5350*	2280				3040*	1760	7301
- 3.0m	9050*	9050*	8780*	6350	6260*	3420	4430*	2310				3920*	2140	6383
- 4.5m	7560*	7560*	5630*	5630*	3860*	3600						3340*	3260	4849

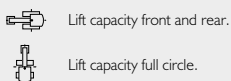













Notes: 1. For lifting capacity including bucket, subtract total weight of bucket or bucket and quickhitch from above values.
 2. Lifting capacities are based on ISO 10567, that is: 75% of minimum tipping load or 87% of hydraulic lift capacity, whichever is the less. Lifting capacities marked* are based on hydraulic capacity.
 3. Lift capacities assume that the machine is on firm, level ground.
 4. Lift capacities may be limited by local regulations. Please refer to your dealer.











LIFT CAPACITIES – DIPPER LENGTH: 2.25M, 5.15M MONOBOOM, REAR STABILISERS, NO BUCKET. JSI75W MONO

Reach	1.5m		3m		4.5m		6m		7.5m		Capacity at Max Reach			
														mm
Load Point Ht.	kg	kg	kg	kg	kg	kg	kg	kg	kg	kg	kg	kg	kg	mm
7.5m					4360*	4360*						3830*	3830*	4620
6.0m					5080*	5080*	3530*	3260				3330*	3230	6031
4.5m					5710*	5050	4890*	3220				3190*	2590	6838
3.0m					6740*	4710	4980	3090				3230*	2310	7248
1.5m					7530*	4420	4830	2950				3440*	2220	7330
0m			5580*	5580*	7450	4260	4730	2860				3710	2290	7094
- 1.5m	6310*	6310*	9440*	8090	6950*	4240	4720	2850				4200	2570	6508
- 3.0m	8760*	8760*	7190*	7190*	5360*	4340						4000*	3350	5454
- 4.5m			2810*	2810*								2280*	2280*	3524

LIFT CAPACITIES – DIPPER LENGTH: 2.70M, 5.15M MONOBOOM, REAR STABILISERS, NO BUCKET. JSI75W MONO

Reach	1.5m		3m		4.5m		6m		7.5m		Capacity at Max Reach			
														mm
Load Point Ht.	kg	kg	kg	kg	kg	kg	kg	kg	kg	kg	kg	kg	kg	mm
7.5m												2880*	2880*	5238
6.0m							4040*	3350				2580*	2580*	6514
4.5m					5290*	5160	4610*	3280				2500*	2380	7266
3.0m			9710*	9010	6360*	4790	5030	3120	3370*	2210		2540*	2140	7653
1.5m			5120*	5120*	7290*	4440	4850	2960	3460	2150		2690*	2050	7731
0m			6660*	6660*	7420	4230	4720	2850	3080*	2110		3020*	2100	7508
- 1.5m	6070*	6070*	10140*	7900	7170*	4170	4670	2810				3630*	2320	6957
- 3.0m	10160*	10160*	8130*	8060	5930*	4240						4020*	2890	5985
- 4.5m			4570*	4570*								3120*	3120*	4307

LIFT CAPACITIES – DIPPER LENGTH: 3.05M, 5.15M MONOBOOM, REAR STABILISERS, NO BUCKET. JSI75W MONO

Reach	1.5m		3m		4.5m		6m		7.5m		Capacity at Max Reach			
														mm
Load Point Ht.	kg	kg	kg	kg	kg	kg	kg	kg	kg	kg	kg	kg	kg	mm
7.5m												2400*	2400*	5690
6.0m							3840*	3360				2170*	2170*	6881
4.5m							4350*	3270	2500*	2250		2110*	2110*	7596
3.0m			8930*	8930*	6020*	4840	4830*	3120	3510	2190		2150*	1980	7967
1.5m			6790*	6790*	7070*	4470	4840	2950	3430	2120		2280*	1800	8041
0m			6950*	6950*	7430	4230	4649	2820	3360	2060		2540*	1940	7828
- 1.5m	5610*	5610*	9860*	7860	7290*	4140	4620	2760				3040*	2120	7301
- 3.0m	9050*	9050*	8780*	7990	6260*	4170	4430*	2790				3920*	2590	6383
- 4.5m	7560*	7560*	5630*	5630*	3860*	3860*						3340*	3340*	4849

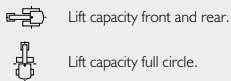

Notes:

1. For lifting capacity including bucket, subtract total weight of bucket or bucket and quickhitch from above values.
2. Lifting capacities are based on ISO 10567, that is: 75% of minimum tipping load or 87% of hydraulic lift capacity, whichever is the less. Lifting capacities marked* are based on hydraulic capacity.
3. Lift capacities assume that the machine is on firm, level ground.
4. Lift capacities may be limited by local regulations. Please refer to your dealer.

LIFT CAPACITIES – DIPPER LENGTH: 2.25M, 5.15M MONOBOOM, FRONT DOZER, REAR STABILISERS, NO BUCKET. JSI75W MONO

Reach	1.5m		3m		4.5m		6m		7.5m		Capacity at Max Reach			
														mm
Load Point Ht.	kg	kg	kg	kg	kg	kg	kg	kg	kg	kg	kg	kg	kg	mm
7.5m					4360*	4360*						3830*	3830*	4620
6.0m					5080*	5080*	3530*	3530*				3330*	3330*	6031
4.5m					5710*	5710*	4890*	4110				3190*	3090*	6838
3.0m					6740*	6160	5250*	3970				3230*	2980	7248
1.5m					7530*	5830	5580*	3830				3440*	2870	7330
0m			5580*	5580*	7600*	5670	5600*	3740				3880*	2970	7094
- 1.5m	6310*	6310*	9440*	9440*	6950*	5650	5060*	3730				4400*	3350	6508
- 3.0m	8760*	8760*	7190*	7190*	5360*	5360*						4000*	4000*	5454
- 4.5m			2810*	2810*								2280*	2280*	3524

LIFT CAPACITIES – DIPPER LENGTH: 2.70M, 5.15M MONOBOOM, FRONT DOZER, REAR STABILISERS, NO BUCKET. JSI75W MONO

Reach	1.5m		3m		4.5m		6m		7.5m		Capacity at Max Reach			
														mm
Load Point Ht.	kg	kg	kg	kg	kg	kg	kg	kg	kg	kg	kg	kg	kg	mm
7.5m												2880*	2880*	5238
6.0m							4040*	4040*				2580*	2580*	6514
4.5m					5290*	5290*	4610*	4170				2500*	2500*	7266
3.0m			9710*	9710*	6360*	6240	5040*	4010	3370*	2850		2540*	2540*	7653
1.5m			5120*	5120*	7290*	5860	5450*	3840	4100*	2780		2690*	2660	7731
0m			6660*	6660*	7590*	5640	5600*	3720	3080*	2740		3020*	2730	7508
- 1.5m	6070*	6070*	10140*	10140*	7170*	5570	5280*	3680				3630*	3030	6957
- 3.0m	10160*	10160*	8130*	8130*	5930*	5640						4020*	3770	5985
- 4.5m			4570*	4570*								3120*	3120*	4307

LIFT CAPACITIES – DIPPER LENGTH: 3.05M, 5.15M MONOBOOM, FRONT DOZER, REAR STABILISERS, NO BUCKET. JSI75W MONO

Reach	1.5m		3m		4.5m		6m		7.5m		Capacity at Max Reach			
														mm
Load Point Ht.	kg	kg	kg	kg	kg	kg	kg	kg	kg	kg	kg	kg	kg	mm
7.5m												2400*	2400*	5690
6.0m							3840*	3840*				2170*	2170*	6881
4.5m							4350*	4170	2500*	2500*		2110*	2110*	7596
3.0m			8930*	8930*	6020*	6020*	4830*	4010	3790*	2830		2150*	2150*	7967
1.5m			6790*	6790*	7070*	5900	5300*	3830	4330*	2750		2280*	2280*	8041
0m			6950*	6950*	7540*	5640	5540*	3700	4320*	2690		2540*	2530	7828
- 1.5m	5610*	5610*	9860*	9860*	7290*	5540	5350*	3630				3040*	2780	7301
- 3.0m	9050*	9050*	8780*	8780*	6260*	5580	4430*	3670				3920*	3380	6383
- 4.5m	7560*	7560*	5630*	5630*	3860*	3860*						3340*	3340*	4849

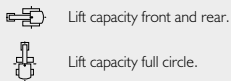



- Notes:**
1. For lifting capacity including bucket, subtract total weight of bucket or bucket and quickhitch from above values.
 2. Lifting capacities are based on ISO 10567, that is: 75% of minimum tipping load or 87% of hydraulic lift capacity, whichever is the less. Lifting capacities marked* are based on hydraulic capacity.
 3. Lift capacities assume that the machine is on firm, level ground.
 4. Lift capacities may be limited by local regulations. Please refer to your dealer.

LIFT CAPACITIES – DIPPER LENGTH: 2.25M, 5.15M MONOBOOM, FRONT STABILISERS, REAR STABILISERS, NO BUCKET. JSI75W MONO

Reach	1.5m		3m		4.5m		6m		7.5m		Capacity at Max Reach			
														mm
Load Point Ht.	kg	kg	kg	kg	kg	kg	kg	kg	kg	kg	kg	kg	kg	mm
7.5m					4360*	4360*						3830*	3830*	4620
6.0m					5080*	5080*	3530*	3530*				3330*	3330*	6031
4.5m					5710*	5710*	4890*	4670				3190*	3190*	6838
3.0m					6740*	6740*	5250*	4520				3230*	3230*	7248
1.5m					7530*	6750	5580*	4380				3440*	3270	7330
0m			5580*	5580*	7600*	6580	5600*	4280				3880*	3390	7094
- 1.5m	6310*	6310*	9440*	9440*	6950*	6550	5060*	4270				4400*	3830	6508
- 3.0m	8760*	8760*	7190*	7190*	5360*	5360*						4000*	4000*	5454
- 4.5m			2810*	2810*								2280*	2280*	3524

LIFT CAPACITIES – DIPPER LENGTH: 2.70M, 5.15M MONOBOOM, FRONT STABILISERS, REAR STABILISERS, NO BUCKET. JSI75W MONO

Reach	1.5m		3m		4.5m		6m		7.5m		Capacity at Max Reach			
														mm
Load Point Ht.	kg	kg	kg	kg	kg	kg	kg	kg	kg	kg	kg	kg	kg	mm
7.5m												2880*	2880*	5238
6.0m							4040*	4040*				2580*	2580*	6514
4.5m					5290*	5290*	4610*	4610*				2500*	2500*	7266
3.0m			9710*	9710*	6360*	6360*	5040*	4570	3370*	3240		2540*	2540*	7653
1.5m			5120*	5120*	7290*	6780	5450*	4390	4100*	3170		2690*	2690*	7731
0m			6660*	6660*	7590*	6550	5600*	4270	3080*	3080		3020*	3020	7508
- 1.5m	6070*	6070*	10140*	10140*	7170*	6480	5280*	4220				3630*	3460	6957
- 3.0m	10160*	10160*	8130*	8130*	5930*	5930*						4020*	4020*	5985
- 4.5m			4570*	4570*								3120*	3120*	4307

LIFT CAPACITIES – DIPPER LENGTH: 3.05M, 5.15M MONOBOOM, FRONT STABILISERS, REAR STABILISERS, NO BUCKET. JSI75W MONO

Reach	1.5m		3m		4.5m		6m		7.5m		Capacity at Max Reach			
														mm
Load Point Ht.	kg	kg	kg	kg	kg	kg	kg	kg	kg	kg	kg	kg	kg	mm
7.5m												2400*	2400*	5690
6.0m							3840*	3840*				2170*	2170*	6881
4.5m							4350*	4350*	2500*	2500*		2110*	2110*	7596
3.0m			8930*	8930*	6020*	6020*	4830*	4560	3790*	3220		2150*	2150*	7967
1.5m			6790*	6790*	7070*	6820	5300*	4380	4330*	3140		2280*	2280*	8041
0m			6950*	6950*	7540*	6550	5540*	4240	4320*	3070		2540*	2540*	7828
- 1.5m	5610*	5610*	9860*	9860*	7290*	6450	5350*	4180				3040*	3040*	7301
- 3.0m	9050*	9050*	8780*	8780*	6260*	6260*	4430*	4210				3920*	3880	6383
- 4.5m	7560*	7560*	5630*	5630*	3860*	3860*						3340*	3340*	4849

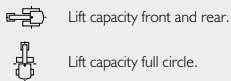

Notes:

1. For lifting capacity including bucket, subtract total weight of bucket or bucket and quickhitch from above values.
2. Lifting capacities are based on ISO 10567, that is: 75% of minimum tipping load or 87% of hydraulic lift capacity, whichever is the less. Lifting capacities marked* are based on hydraulic capacity.
3. Lift capacities assume that the machine is on firm, level ground.
4. Lift capacities may be limited by local regulations. Please refer to your dealer.

LIFT CAPACITIES – DIPPER LENGTH: 2.25M, 4.97M T.A.B., REAR DOZER, NO BUCKET.													JSI75W T.A.B.	
Reach	1.5m		3m		4.5m		6m		7.5m		Capacity at Max Reach		mm	
														
Load Point Ht.	kg	kg	kg	kg	kg	kg	kg	kg	kg	kg	kg	kg	kg	
7.5m												4240*	4240*	4492
6.0m					4690*	4560						3510*	2810	5935
4.5m			6720*	6720*	5250*	4360	4630*	2750				3270*	2230	6753
3.0m					6270*	4020	4990*	2630				3230*	1970	7168
1.5m					7190*	3700	5390*	2480				3350*	1880	7251
0m			5340*	5340*	7530*	3520	5540*	2390				3670*	1940	7013
- 1.5m			10110*	6460	7130*	3500	5140*	2380				4330*	2200	6419
- 3.0m					5670*	3610						5100*	3240	4882

LIFT CAPACITIES – DIPPER LENGTH: 2.70M, 4.97M T.A.B., REAR DOZER, NO BUCKET.													JSI75W T.A.B.	
Reach	1.5m		3m		4.5m		6m		7.5m		Capacity at Max Reach		mm	
														
Load Point Ht.	kg	kg	kg	kg	kg	kg	kg	kg	kg	kg	kg	kg	kg	
7.5m					4410*	4410*						3120*	3120*	5155
6.0m					4240*	4240*	4170*	2880				2700*	2500	6448
4.5m					4820*	4480	4330*	2820				2550*	2040	7207
3.0m			8730*	7550	5870*	4110	4750*	2670	3200*	1860		2530*	1810	7597
1.5m					6900*	3730	5220*	2500	3880*	1800		2630*	1730	7675
0m			6410*	6280	7430*	3500	5490*	2380				2870*	1770	7451
- 1.5m			10500*	6290	7270*	3430	5330*	2330				3340*	1970	6895
- 3.0m			8830*	6460	6230*	3500						4150*	2480	5913

LIFT CAPACITIES – DIPPER LENGTH: 3.05M, 4.97M T.A.B., REAR DOZER, NO BUCKET.													JSI75W T.A.B.	
Reach	1.5m		3m		4.5m		6m		7.5m		Capacity at Max Reach		mm	
														
Load Point Ht.	kg	kg	kg	kg	kg	kg	kg	kg	kg	kg	kg	kg	kg	
7.5m												2580*	2580*	5629
6.0m							3860*	2900				2270*	2250	6831
4.5m					4440*	4440*	4050*	2820	2430*	1880		2150*	1860	7551
3.0m			7950*	7800	5520*	4150	4520*	2670	3790*	1840		2140*	1660	7924
1.5m			6890*	6730	6650*	3760	5040*	2490	4210*	1770		2230*	1590	7998
0m			6710*	6310	7320*	3500	5400*	2350	4210*	1710		2420*	1620	7784
- 1.5m	5120*	5120*	9850*	6250	7330*	3400	5370*	2290				2800*	1790	7254
- 3.0m			9410*	6380	6530*	3430	4540*	2330				3590*	2200	6329

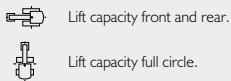

Notes: 1. For lifting capacity including bucket, subtract total weight of bucket or bucket and quickhitch from above values.
 2. Lifting capacities are based on ISO 10567, that is: 75% of minimum tipping load or 87% of hydraulic lift capacity, whichever is the less. Lifting capacities marked* are based on hydraulic capacity.
 3. Lift capacities assume that the machine is on firm, level ground.
 4. Lift capacities may be limited by local regulations. Please refer to your dealer.













LIFT CAPACITIES – DIPPER LENGTH: 2.25M, 4.97M T.A.B., REAR STABILISERS, NO BUCKET. JSI75W T.A.B.

Reach	1.5m		3m		4.5m		6m		7.5m		Capacity at Max Reach		mm	
														
Load Point Ht.	kg	kg	kg	kg	kg	kg	kg	kg	kg	kg	kg	kg	mm	
7.5m												4240*	4240*	4492
6.0m					4690*	4690*						3510*	3330	5935
4.5m			6720*	6720*	5250*	5170	4630*	3260				3270*	2660	6753
3.0m					6270*	4810	4990*	3130				3230*	2360	7168
1.5m					7190*	4480	4930	2980				3350*	2260	7251
0m			5340*	5340*	7530*	4300	4820	2890				3670*	2340	7013
- 1.5m			10110*	8130	7130*	4270	4810	2880				4330*	2650	6419
- 3.0m					5670*	4390						5100*	3920	4882

LIFT CAPACITIES – DIPPER LENGTH: 2.70M, 4.97M T.A.B., REAR STABILISERS, NO BUCKET. JSI75W T.A.B.

Reach	1.5m		3m		4.5m		6m		7.5m		Capacity at Max Reach		mm	
														
Load Point Ht.	kg	kg	kg	kg	kg	kg	kg	kg	kg	kg	kg	kg	mm	
7.5m					4410*	4410*						3120*	3120*	5155
6.0m					4240*	4240*	4170*	3400				2700*	2700*	6448
4.5m					4820*	4820*	4330*	3330				2550*	2430	7207
3.0m			8730*	8730*	5870*	4910	4750*	3180	3200*	2220		2530*	2170	7597
1.5m					6900*	4520	4960	3000	3520	2160		2630*	2090	7675
0m			6410*	6410*	7430*	4280	4810	2870				2870*	2140	7451
- 1.5m			10500*	7950	7270*	4200	4760	2830				3340*	2380	6895
- 3.0m			8830*	8140	6230*	4280						4150*	2990	5913

LIFT CAPACITIES – DIPPER LENGTH: 3.05M, 4.97M T.A.B., REAR DOZER, NO BUCKET. JSI75W T.A.B.

Reach	1.5m		3m		4.5m		6m		7.5m		Capacity at Max Reach		mm	
														
Load Point Ht.	kg	kg	kg	kg	kg	kg	kg	kg	kg	kg	kg	kg	mm	
7.5m												2580*	2580*	5629
6.0m							3860*	3420				2270*	2270*	6831
4.5m					4440*	4440*	4050*	3340	2430*	2250		2150*	2150*	7551
3.0m			7950*	7950*	5520*	4960	4520*	3180	3580	2210		2140*	2000	7924
1.5m			6890*	6890*	6650*	4550	4950	2990	3490	2130		2230*	1920	7998
0m			6710*	6710*	7320*	4280	4790	2850	3430	2070		2420*	1970	7784
- 1.5m	5120*	5120*	9850*	7920	7330*	4170	4710	2780				2800*	2170	7254
- 3.0m			9410*	8050	6530*	4210	4540*	2830				3590*	2660	6329

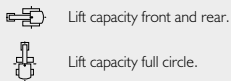

Notes:

1. For lifting capacity including bucket, subtract total weight of bucket or bucket and quickhitch from above values.
2. Lifting capacities are based on ISO 10567, that is: 75% of minimum tipping load or 87% of hydraulic lift capacity, whichever is the less. Lifting capacities marked* are based on hydraulic capacity.
3. Lift capacities assume that the machine is on firm, level ground.
4. Lift capacities may be limited by local regulations. Please refer to your dealer.

LIFT CAPACITIES – DIPPER LENGTH: 2.25M, 4.97M T.A.B., FRONT DOZER, REAR STABILISERS, NO BUCKET.													JSI75W T.A.B.	
Reach	1.5m		3m		4.5m		6m		7.5m		Capacity at Max Reach			
														
Load Point Ht.	kg	kg	kg	kg	kg	kg	kg	kg	kg	kg	kg	kg	mm	
7.5m												4240*	4240*	4492
6.0m					4690*	4690*						3510*	3510*	5935
4.5m			6720*	6720*	5250*	5250*	4630*	4180				3270*	3270*	6753
3.0m					6270*	6270*	4990*	4040				3230*	3050	7168
1.5m					7190*	5940	5390*	3890				3350*	2950	7251
0m			5340*	5340*	7530*	5750	5540*	3790				3670*	3060	7013
-1.5m			10110*	10110*	7130*	5710	5140*	3780				4330*	3470	6419
-3.0m					5670*	5670*						5100*	5100*	4882

LIFT CAPACITIES – DIPPER LENGTH: 2.70M, 4.97M T.A.B., FRONT DOZER, REAR STABILISERS, NO BUCKET.													JSI75W T.A.B.	
Reach	1.5m		3m		4.5m		6m		7.5m		Capacity at Max Reach			
														
Load Point Ht.	kg	kg	kg	kg	kg	kg	kg	kg	kg	kg	kg	kg	mm	
7.5m					4410*	4410*						3120*	3120*	5155
6.0m					4240*	4240*	4170*	4170*				2700*	2700*	6448
4.5m					4820*	4820*	4330*	4260				2550*	2550*	7207
3.0m			8730*	8730*	5870*	5870*	4750*	4090	3200*	2880		2530*	2530*	7597
1.5m					6900*	5980	5220*	3910	3880*	2810		2630*	2630*	7675
0m			6410*	6410*	7430*	5720	5490*	3770				2870*	2800	7451
-1.5m			10500*	10500*	7270*	5640	5330*	3730				3340*	3110	6895
-3.0m			8830*	8830*	6230*	5720						4150*	3910	5913

LIFT CAPACITIES – DIPPER LENGTH: 3.05M, 4.97M T.A.B., FRONT DOZER, REAR STABILISERS, NO BUCKET.													JSI75W T.A.B.	
Reach	1.5m		3m		4.5m		6m		7.5m		Capacity at Max Reach			
														
Load Point Ht.	kg	kg	kg	kg	kg	kg	kg	kg	kg	kg	kg	kg	mm	
7.5m												2580*	2580*	5629
6.0m							3860*	3860*				2270*	2270*	6831
4.5m					4440*	4440*	4050*	4050*	2430*	2430*		2150*	2150*	7551
3.0m			7950*	7950*	5520*	5520*	4520*	4090	3790*	2870		2140*	2140*	7924
1.5m			6890*	6890*	6650*	6020	5040*	3900	4210*	2790		2230*	2230*	7998
0m			6710*	6710*	7320*	5730	5400*	3750	4210*	2720		2420*	2420*	7784
-1.5m	5120*	5120*	9850*	9850*	7330*	5610	5370*	3680				2800*	2800*	7254
-3.0m			9410*	9410*	6530*	5650	4540*	3730				3590*	3490	6329

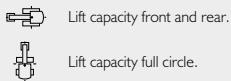







Notes: 1. For lifting capacity including bucket, subtract total weight of bucket or bucket and quickhitch from above values.
 2. Lifting capacities are based on ISO 10567, that is: 75% of minimum tipping load or 87% of hydraulic lift capacity, whichever is the less. Lifting capacities marked* are based on hydraulic capacity.
 3. Lift capacities assume that the machine is on firm, level ground.
 4. Lift capacities may be limited by local regulations. Please refer to your dealer.

LIFT CAPACITIES – DIPPER LENGTH: 2.25M, 4.97M T.A.B., FRONT STABILISERS, REAR STABILISERS, NO BUCKET. JSI75W T.A.B.

Reach	1.5m		3m		4.5m		6m		7.5m		Capacity at Max Reach			
														
Load Point Ht.	kg	kg	kg	kg	kg	kg	kg	kg	kg	kg	kg	kg	mm	
7.5m												4240*	4240*	4492
6.0m					4690*	4690*						3510*	3510*	5935
4.5m			6720*	6720*	5250*	5250*	4630*	4630*				3270*	3270*	6753
3.0m					6270*	6270*	4990*	4610				3230*	3230*	7168
1.5m					7190*	6880	5390*	4450				3350*	3350*	7251
0m			5340*	5340*	7530*	6680	5540*	4340				3670*	3490	7013
- 1.5m			10110*	10110*	7130*	6640	5140*	4330				4330*	3970	6419
- 3.0m					5670*	5670*						5100*	5100*	4882

LIFT CAPACITIES – DIPPER LENGTH: 2.70M, 4.97M T.A.B., FRONT STABILISERS, REAR STABILISERS, NO BUCKET. JSI75W T.A.B.

Reach	1.5m		3m		4.5m		6m		7.5m		Capacity at Max Reach			
														
Load Point Ht.	kg	kg	kg	kg	kg	kg	kg	kg	kg	kg	kg	kg	mm	
7.5m					4410*	4410*						3120*	3120*	5155
6.0m					4240*	4240*	4170*	4170*				2700*	2700*	6448
4.5m					4820*	4820*	4330*	4330*				2550*	2550*	7207
3.0m			8730*	8730*	5870*	5870*	4750*	4660	3200*	3200*		2530*	2530*	7597
1.5m					6900*	6900*	5220*	4470	3880*	3210		2630*	2630*	7657
0m			6410*	6410*	7430*	6660	5490*	4330				2870*	2870*	7451
- 1.5m			10500*	10500*	7270*	6570	5330*	4290				3340*	3340*	6895
- 3.0m			8830*	8830*	6230*	6230*						4150*	4150*	5913

LIFT CAPACITIES – DIPPER LENGTH: 3.05M, 4.97M T.A.B., FRONT STABILISERS, REAR STABILISERS, NO BUCKET. JSI75W T.A.B.

Reach	1.5m		3m		4.5m		6m		7.5m		Capacity at Max Reach			
														
Load Point Ht.	kg	kg	kg	kg	kg	kg	kg	kg	kg	kg	kg	kg	mm	
7.5m												2580*	2580*	5629
6.0m							3860*	3860*				2270*	2270*	6831
4.5m					4440*	4440*	4050*	4050*	2430*	2430*		2150*	2150*	7551
3.0m			7950*	7950*	5520*	5520*	4520*	4520*	3790*	3260		2140*	2140*	7924
1.5m			6890*	6890*	6650*	6650*	5040*	4460	4210*	3180		2230*	2230*	7998
0m			6710*	6710*	7320*	6660	5400*	4310	4210*	3126		2420*	2420*	7784
- 1.5m	5120*	5120*	9850*	9850*	7330*	6540	5370*	4240				2800*	2800*	7254
- 3.0m			9410*	9410*	6530*	6530*	4540*	4290				3590*	3590*	6329

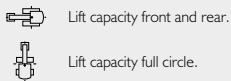

Notes:

1. For lifting capacity including bucket, subtract total weight of bucket or bucket and quickhitch from above values.
2. Lifting capacities are based on ISO 10567, that is: 75% of minimum tipping load or 87% of hydraulic lift capacity, whichever is the less. Lifting capacities marked* are based on hydraulic capacity.
3. Lift capacities assume that the machine is on firm, level ground.
4. Lift capacities may be limited by local regulations. Please refer to your dealer.



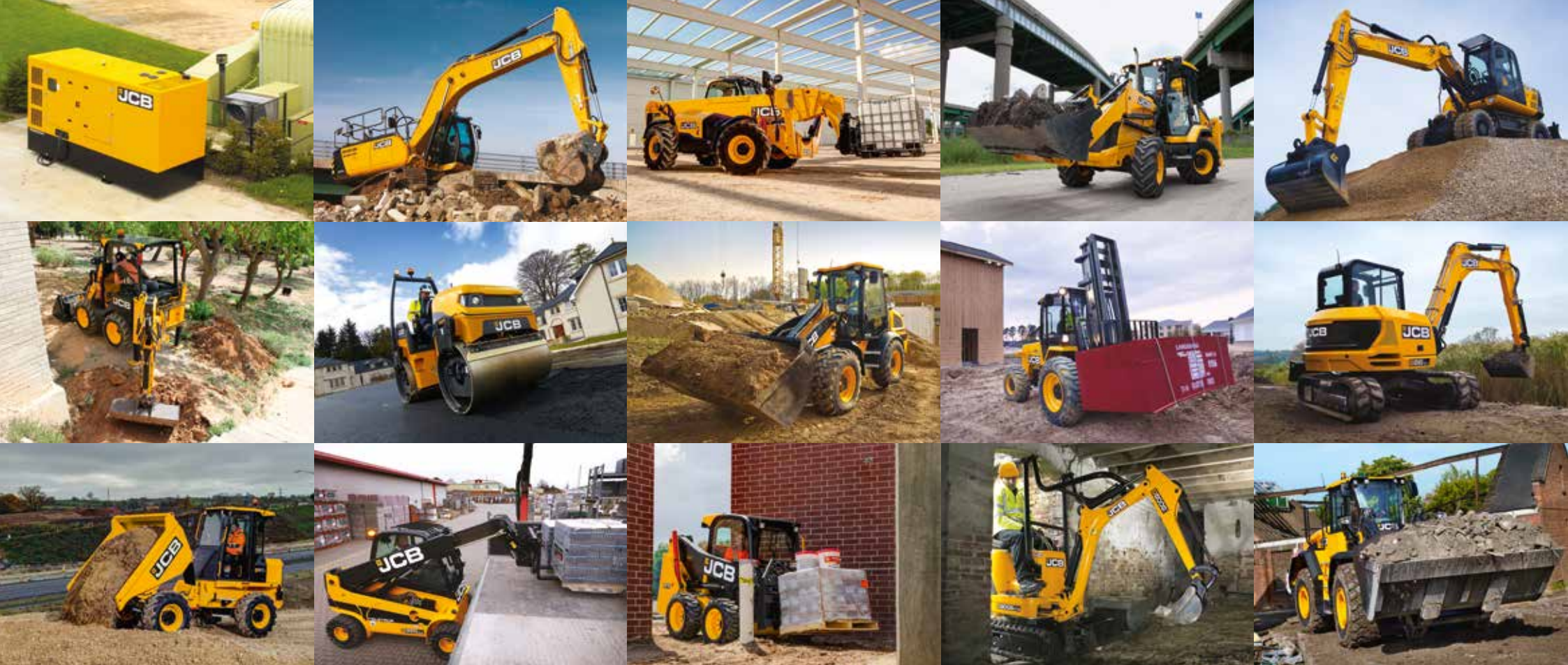

ONE COMPANY, OVER 300 MACHINES.

Your nearest JCB dealer

Wheeled Excavator JS175W

Engine power: 129kW (172hp) Operating weight: 15,010 – 18,417kg
 Bucket capacity: 0.265 – 0.995m³

JCB Sales Limited, Rokester, Staffordshire, United Kingdom ST14 5JP.
 Tel: +44 (0)1889 590312 Email: salesinfo@jcb.com
 Download the very latest information on this product range at: www.jcb.com

©2009 JCB Sales. All rights reserved. No part of this publication may be reproduced, stored in a retrieval system, or transmitted in any form or by any other means, electronic, mechanical, photocopying or otherwise, without prior permission from JCB Sales. All references in this publication to operating weights, sizes, capacities and other performance measurements are provided for guidance only and may vary dependant upon the exact specification of machine. They should not therefore be relied upon in relation to suitability for a particular application. Guidance and advice should always be sought from your JCB Dealer. JCB reserves the right to change specifications without notice. Illustrations and specifications shown may include optional equipment and accessories. The JCB logo is a registered trademark of J.C. Bamford Excavators Ltd.

